

RIHO

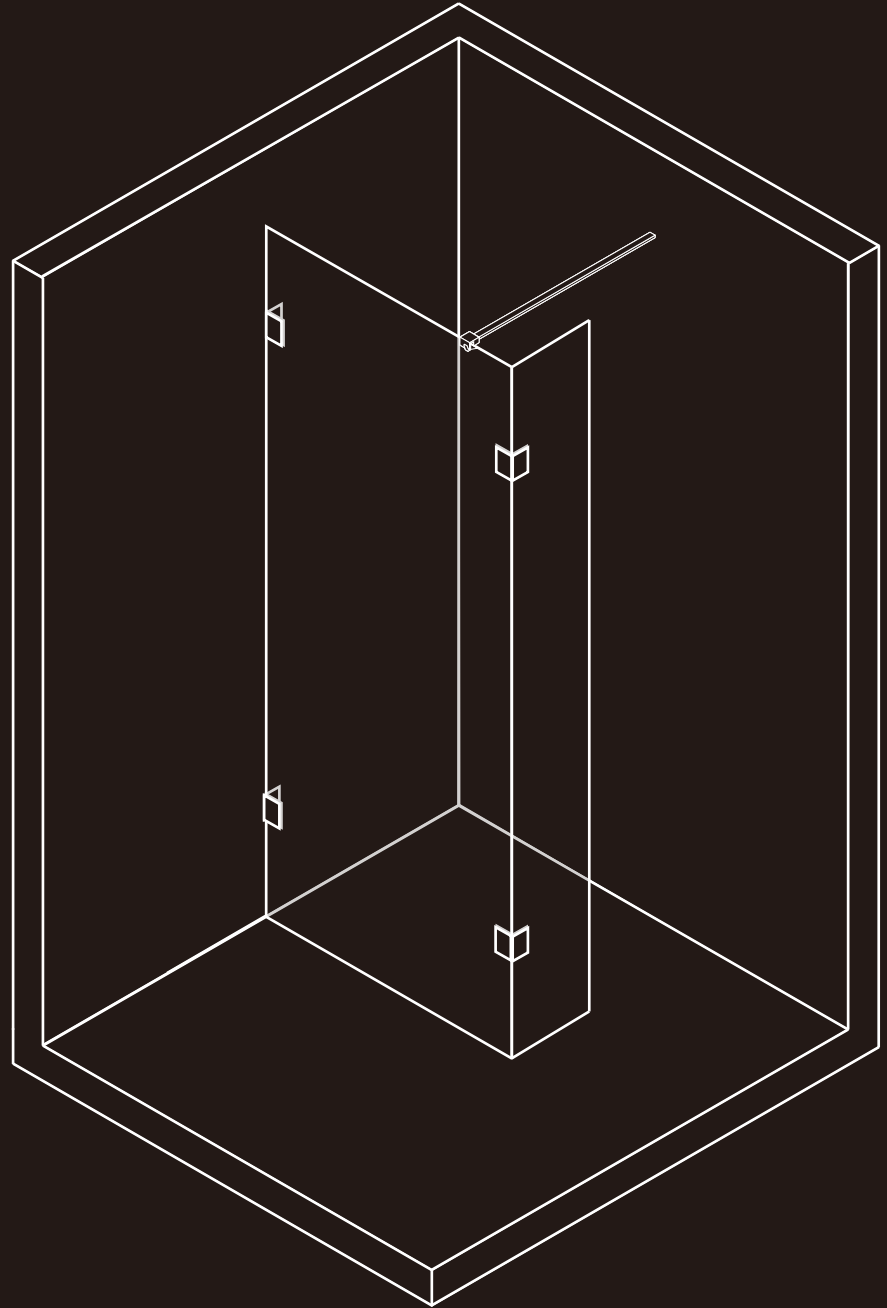

SCANDIC NXT X402

Installatiehandleiding | Installation manual | Manuel d'installation |
Montageanleitung | Návod k instalaci | Instrukcja instalacji |
Telepítési kézikönyv | Руководство по установке

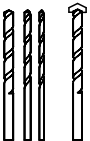
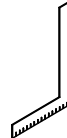
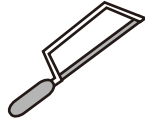
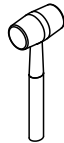
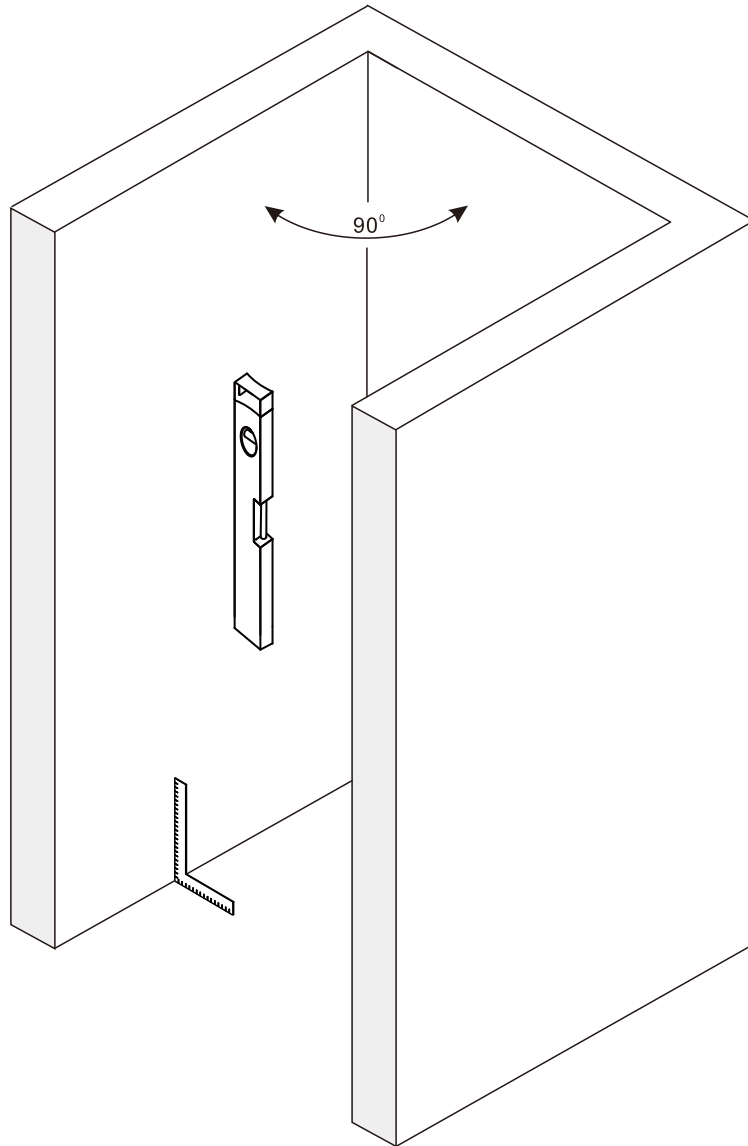

Ø6mm

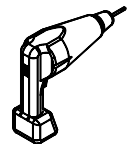
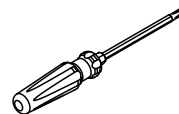
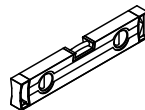
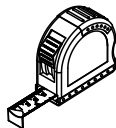
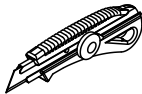

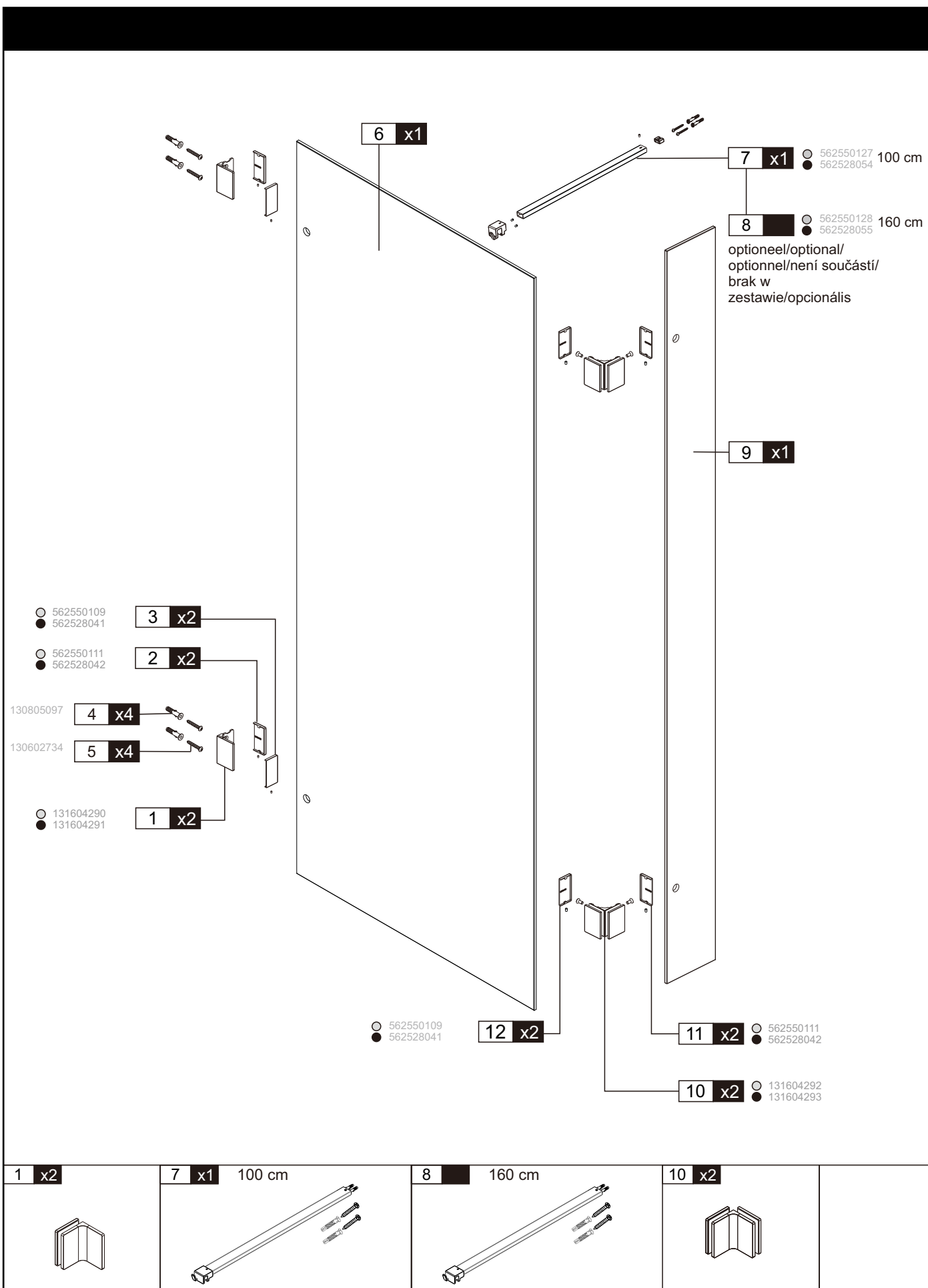

(968mm ~ 972mm)
 (1068mm ~ 1072mm)
 (1168mm ~ 1172mm)
 (1368mm ~ 1372mm)
 (1568mm ~ 1572mm)

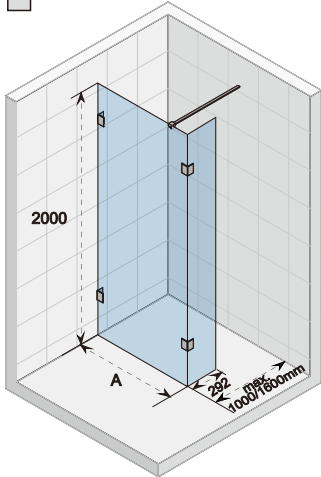
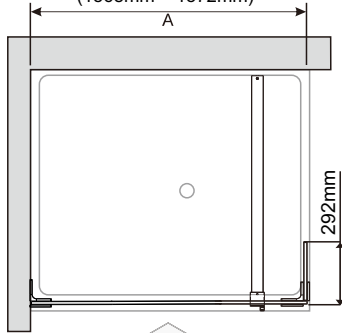

(968mm ~ 972mm)
 (1068mm ~ 1072mm)
 (1168mm ~ 1172mm)
 (1368mm ~ 1372mm)
 (1568mm ~ 1572mm)

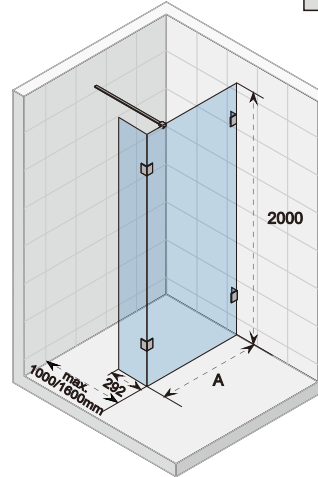
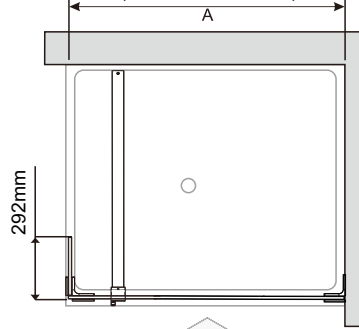

01

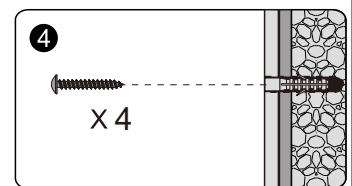
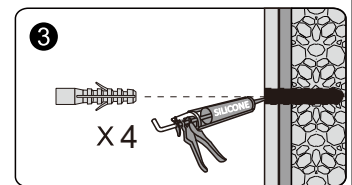
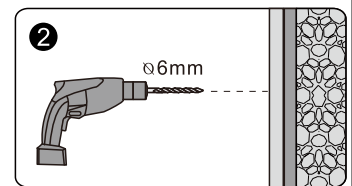
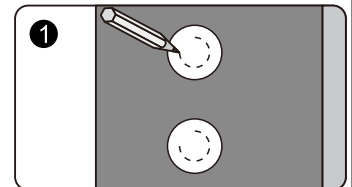
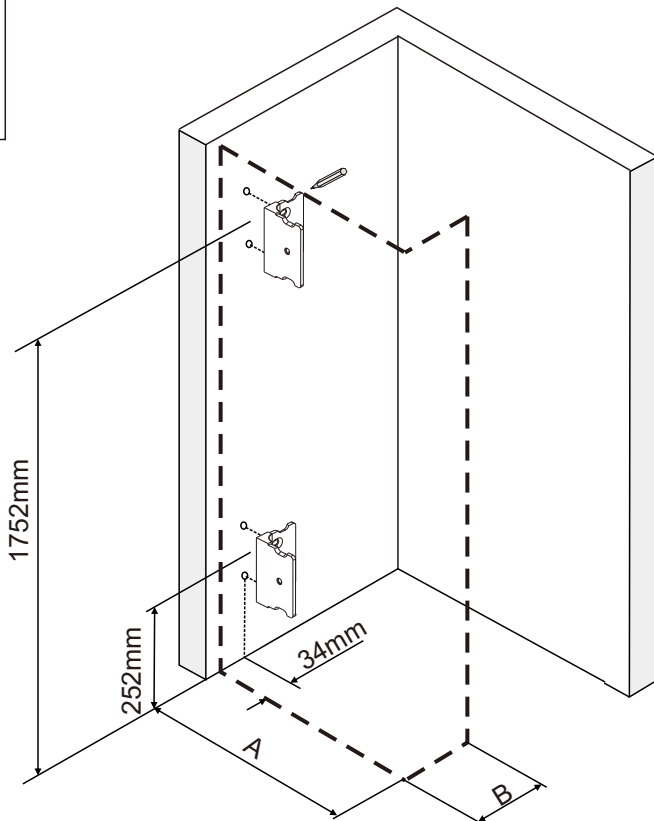
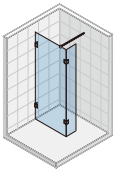

02

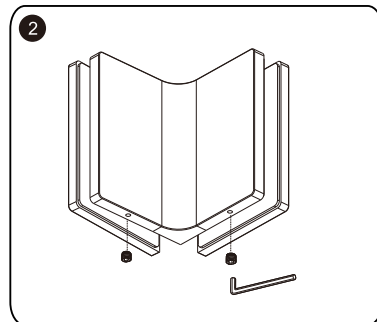
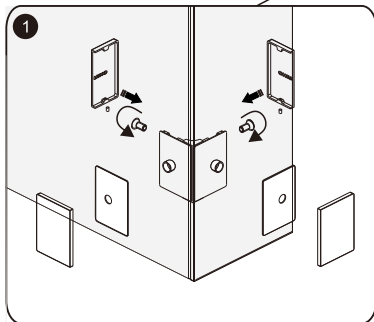
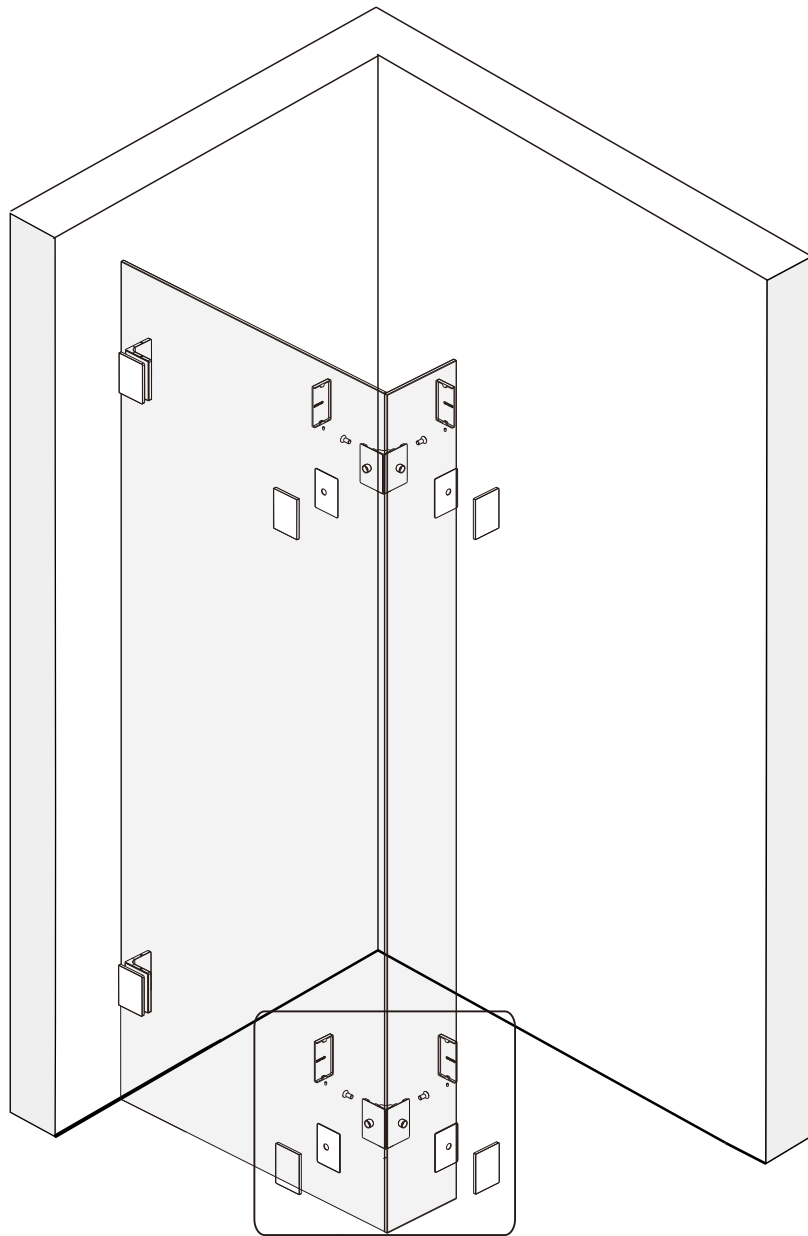

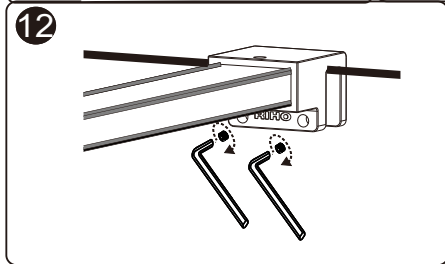
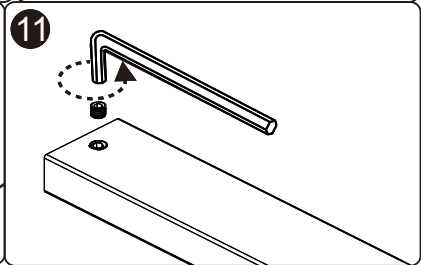
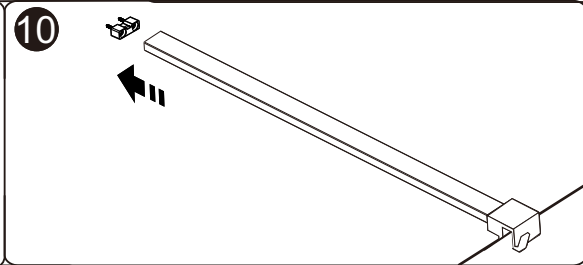
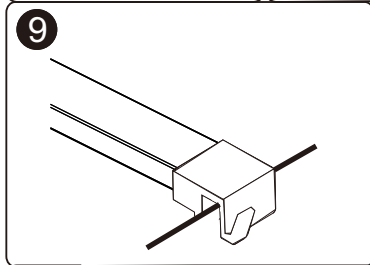
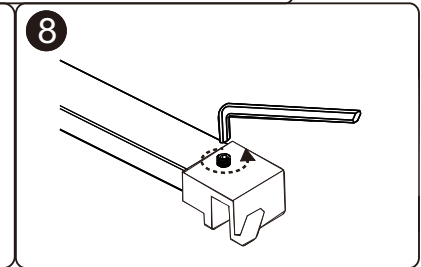
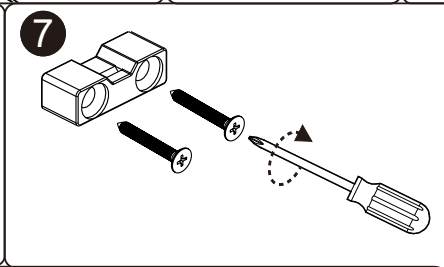
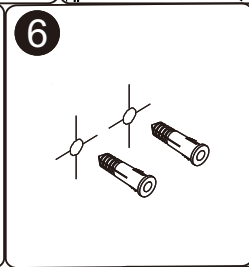
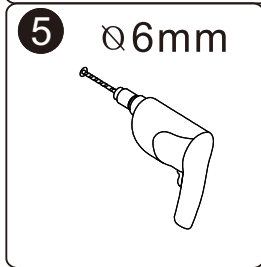
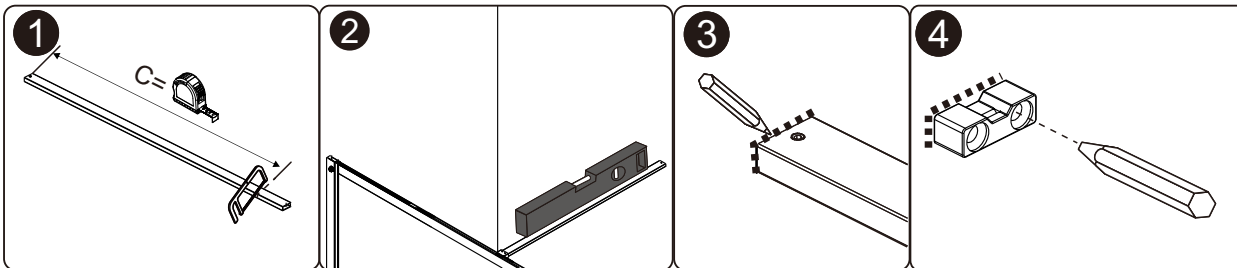
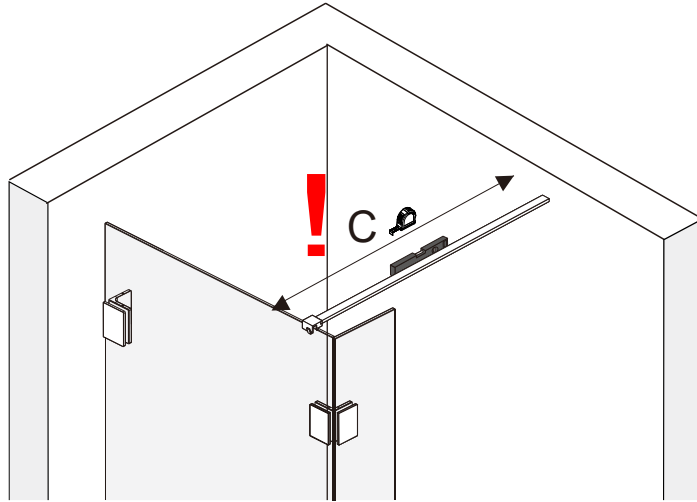
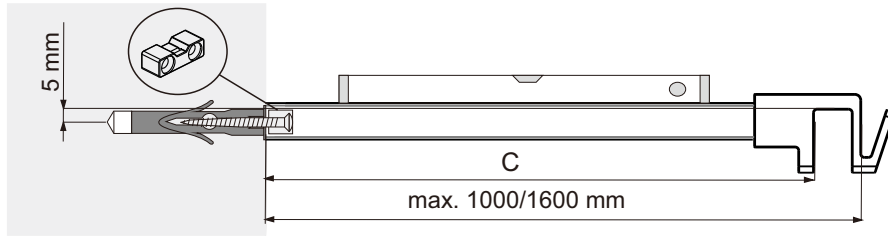

04

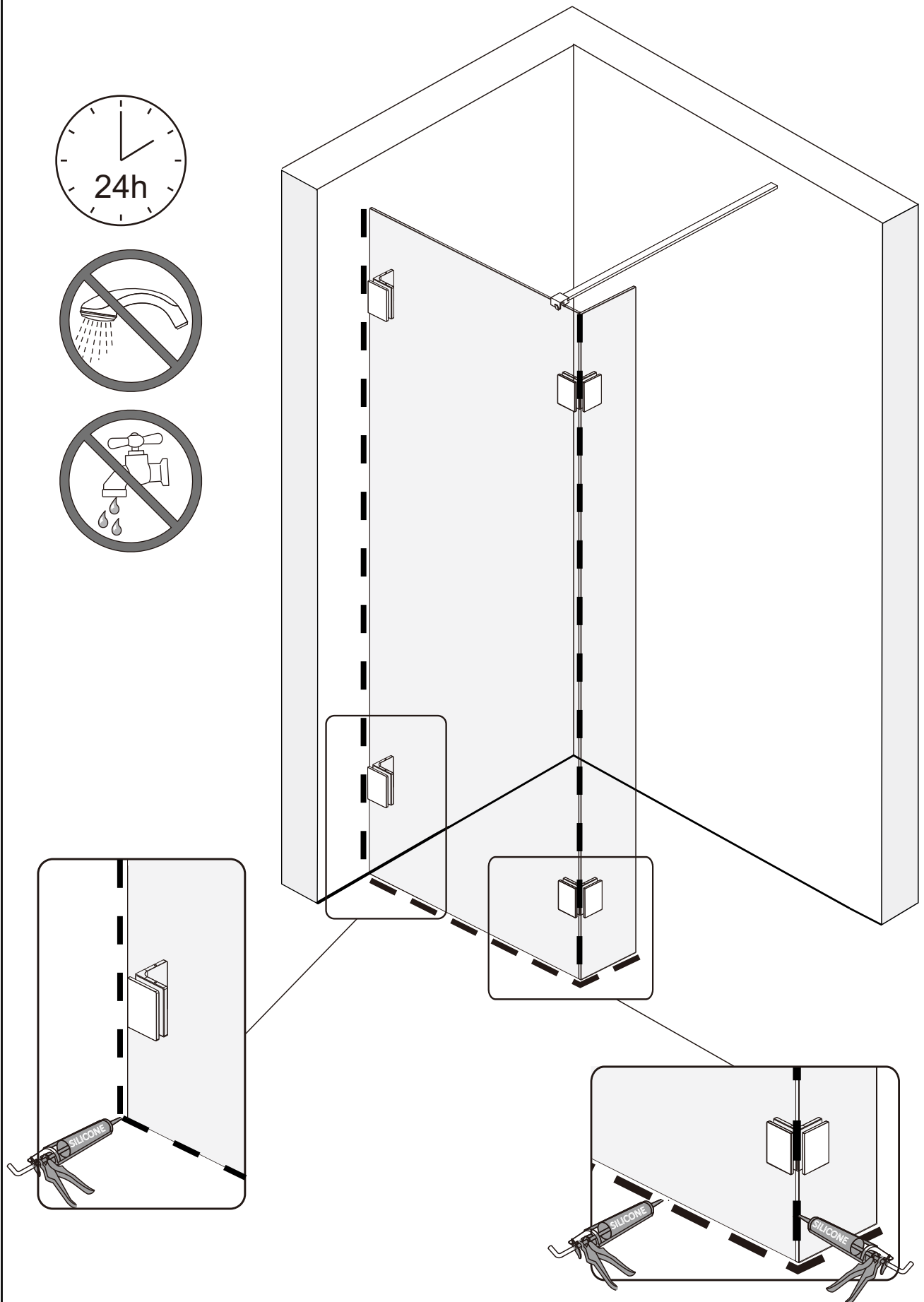

RIHO

NL **RIHO International b.v.**
Hermesstraat 10
5047TS Tilburg
Netherlands
T: +31-(0)13 5728728
F: +31-(0)13 5720262
E: info@riho.nl

B **RIHO Belgium b.v.b.a**
Nijverheidslaan 27
3290 Diest
Belgium
T: +32-(0)13 314780
F: +32-(0)13 336604
E: service@riho.be

D **RIHO Sanitär-Vertriebs GmbH**
Adlerstrasse 4 – 8
58708 Menden
Germany
T: +49-(0)2373 933 93 30
F: +49-(0)2373 933 93 40
E: info@riho.de

PL **RIHO Polska Sp. z o.o.**
ul. Zgierska 250/252
91-364 Łódź
Poland
T: +48-(0)42 2506258
F: +48-(0)42 2506257
E: biuro@riho.pl

CZ **RIHO CZ, a.s.**
Suchý 37
680 01 Boskovice
Czech Republic
T: +42-(0)516 468222
F: +42-(0)516 468216
E: info@riho.cz

H **RIHO Magyarország Kft.**
Budafoki út 60
1117 Budapest
Hungary
T: +06 1 696 11 02
F: +06 1 696 11 03
E: info@riho.hu

Internet (Интернет)
WWW.RIHO.COM
WWW.RIHO.CZ

Aan foutief opgegeven uitvoeringen/specificaties e.d. kunnen geen rechten ontleend worden. Druk-en zetfouten voorbehouden.

No rights can be granted in case of erroneously entered models/specifications etc. Printing and typesetting errors reserved.

Aus falschen Angaben zu Ausführungen/Spezifikationen u. dgl. können keinerlei Rechte abgeleitet werden. Druck- und Satzfehler vorbehalten.

Aucune obligation légale ne peut découler des éventuelles mentions erronées de caractéristiques, spécifications, etc. Sous réserve d'erreurs typographiques ou d'impression.

V případě chybně uvedených modelů, specifikací atd. nelze uplatňovat žádné právní nároky. Chyby tisku a sazby vyhrazeny.

Błędy w nazwie modelu/parametrach technicznych, itp., nie upoważniają do jakichkolwiek roszczeń. Producent nie ponosi odpowiedzialności za błędy w druku i składzie tekstu.

A hibásan bevezetett modellek, műszaki adatok stb. nem biztosítanak további jogokat a vásárlónak. A nyomdai és tördelési hibák jogát fenntartjuk.

В случае неправильно указанных моделей, технических характеристик и т.д., не могут быть предъявлены никакие юридические претензии. Опечатки и ошибки исключены.

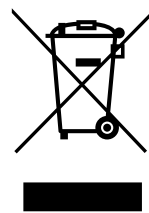

IW01421.2
110104366